

---

---

# WHOLESALE CATALOG

---

---

*PenCraft*



5 BROMFIELD STREET ~ BOSTON, MASS.

---

---

PENS — PARTS — TOOLS  
ACCESSORIES

---

---

---

---

# PEN REPAIRS MEAN EXTRA PROFITS FOR YOU!

---

---

*Make More Money*

INCREASE PROFITABLE TRAFFIC IN YOUR STORE

BUILD MORE SATISFIED CUSTOMERS

CASH IN ON A STEADY CONSISTENT BUSINESS . . .

*The Investment Is Small . . .  
The Profits Are Big*

---

---

## MILLIONS OF PENS REQUIRE REPAIRS DAILY

Hundreds of Pens in Your Community Require Servicing . . .

Get This Business and Bring New Customers to Your Store

*PenCraft* Tells You How in the Following Pages . . .

# COMPLETE PEN REPAIR KIT

## Enough to Start Your New Department

### HERE'S WHAT YOU GET

- |                           |                               |
|---------------------------|-------------------------------|
| 1. Pencraft Repair Manual | 16. Celluloid Cement          |
| 2. 6 Dozen Assorted Sacs  | 17. Cleaning Bulb             |
| 3. Sac Spreader           | 18. Feed Brush                |
| 4. Sac Hook               | 19. Flat File                 |
| 5. Alcohol Lamp           | 20. Triangular File           |
| 6. Pen Section Block      | 21. Drill Chuck               |
| 7. Driver Pilot           | 22. 3 Drills                  |
| 8. Buffing Stick          | 23. Bench Vise                |
| 9. Polishing Rouge        | 24. Burnisher                 |
| 10. Pen Point Pliers      | 25. Tweezers                  |
| 11. Magnifying Glass      | 26. Dozen Assorted Feeds      |
| 12. Smoothing Paper       | 27. Dozen Assorted Press Bars |
| 13. Hammer                | 28. Doz. Asst. Process Points |
| 14. Repair Sign           | 29. 100 Repair Envelopes      |
| 15. Sac Cement            | 30. Round Brush for Caps      |

As Illustrated on Opposite Page 

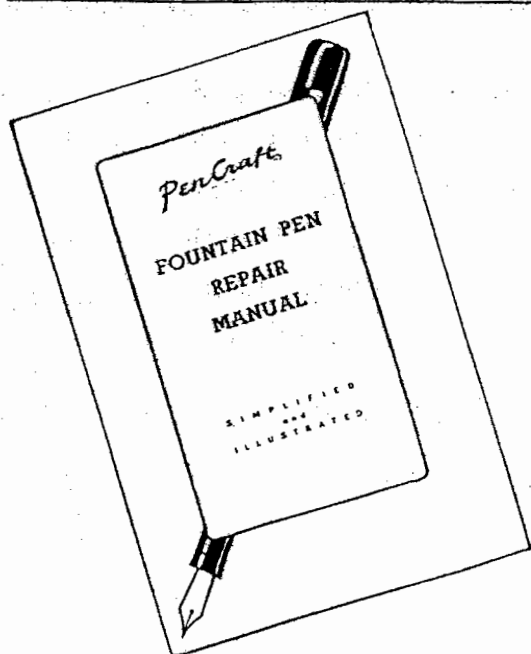

Anyone with the least bit of mechanical ability should experience little trouble in repairing fountain pens if the operation is followed out according to steps described in THE PENCRAFT MANUAL.

### FREE WITH REPAIR KIT

When Ordered  
Separately  
50c PER COPY

### OUR MONEY BACK GUARANTEE

We absolutely agree to refund your money (less 10 per cent. for handling charges) for any merchandise that you cannot sell, or do not wish to keep, returned to us in first-class condition within 30 days from date of purchase.

PRICES SUBJECT TO CHANGE WITHOUT NOTICE

PENCRAFT, INC. • 5 BROMFIELD STREET • BOSTON, MASS.





**TWO-WAY BURNISHER**

Hardened Steel  
Highly Polished—Hard Rubber Handle  
75c



**POINT BURNISHING BLOCK**

Made of Solid Steel  
None Better for Straightening Bent Points

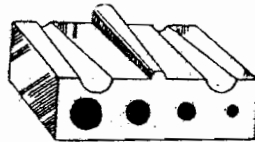

Each \$2.50

With Two-Way Burnisher  
**\$3.00**

**BURNISHER**

Tempered Steel  
Highly Polished



Lacquered Wood Handle  
50c each

**SAC SPREADERS**

For Stretching Rubber Sac

25c each

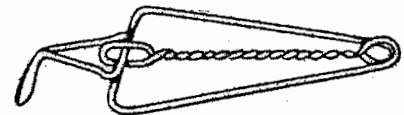

**HIGH POWER MAGNIFIER**

1/4" x 1/4" Lens  
50c

1/2" x 1/2" Lens  
75c

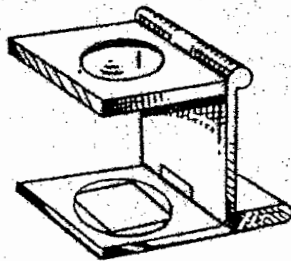

**PEN SECTION BLOCK**

Used for Driving feed and gold pen from point section.

60c

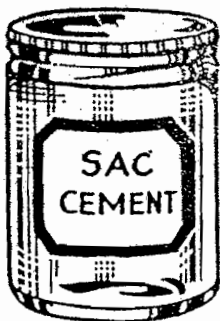
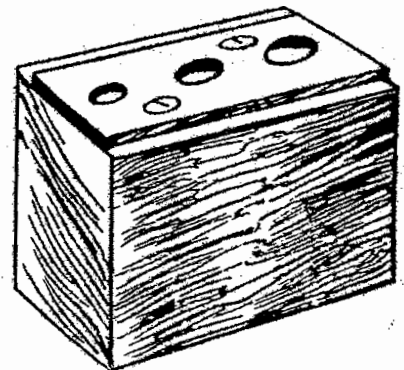

**SAC CEMENT**

For attaching rubber sac to point section.

15c Bottle

Will mend anything made of celluloid, tortoise shell or pyrolyn. Practical and economical.

25c

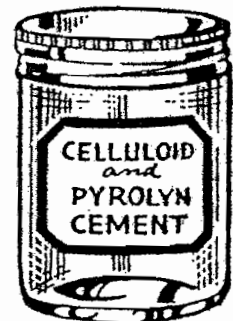

**FOUNTAIN PEN BOXES**

For display or mailing, strong and durable, covered with brown kraft paper 6 1/8 in. by 1 1/16 in.  
30c doz. \$2.00 per hundred \$16.00 per thousand

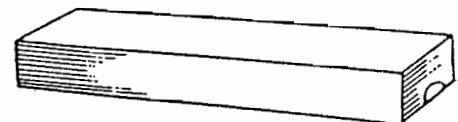

# FIRST QUALITY HARD IRIIDIUM 14K GOLD POINTS

LARGER SIZES — BETTER VALUE THAN EVER — AT A LOWER PRICE

ORDER SAMPLES AND COMPARE WITH ANY YOU HAVE USED

Tipped with the highest quality IRIIDIUM to insure long wear, smoothness and complete writing satisfaction. High standards of manufacture plus rigid inspection is your guarantee of absolute quality.

Complete Assortment  
\$3.75

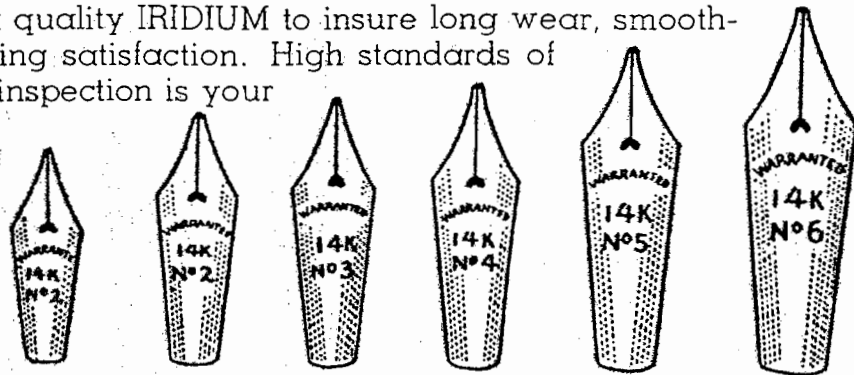

Each	35c	48c	60c	70c	80c	90c
Dozen	\$4.00	\$5.50	\$7.00	\$8.20	\$9.40	\$10.50

## SAVE MORE THAN HALF ON THIS ASSORTMENT

Special value 12 gold pen point assortment with alloy IRIIDIUM tip points. Good value.  
Per dozen ..... \$5.00

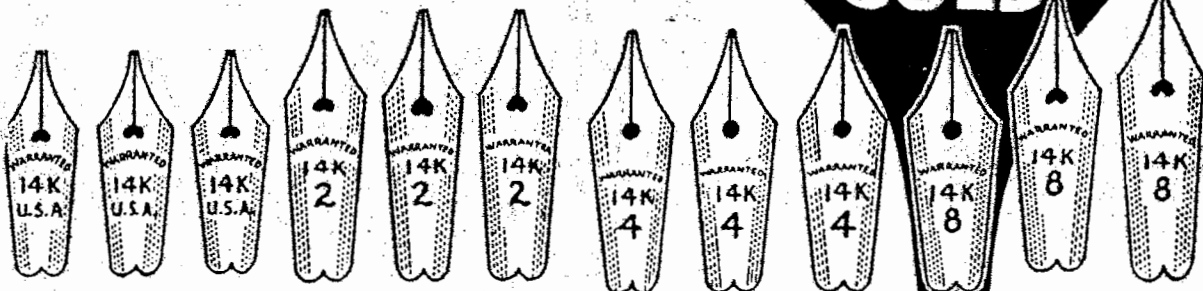

### Alloy Iridium Tip Points 14K Gold

No. 19	Each 25c	Doz. \$3.00	No. 28	Each 43c	Doz. \$5.00
No. 21	Each 32c	Doz. 3.70	No. 31	Each 47c	Doz. 5.50
No. 23	Each 34c	Doz. 3.95	No. 32	Each 47c	Doz. 5.50
No. 24	Each 35c	Doz. 4.00	No. 50	Each 70c	Doz. 8.25

### DURIUM PEN POINTS

A new point far superior to the gold-plated or plain steel point. Smooth writing, non-tarnishable Durium Pen Points will give complete satisfaction.

Sizes 2 and 4 ..... Dozen, 35c Gross, \$2.90  
 Sizes 6, 7 and 8 ..... Dozen, 40c Gross, \$3.00

### Durium Two-Tone Nibs

4 ..... Dozen, 40c Gross, \$3.50  
 6 and 8 ..... Dozen, 50c Gross, \$3.75

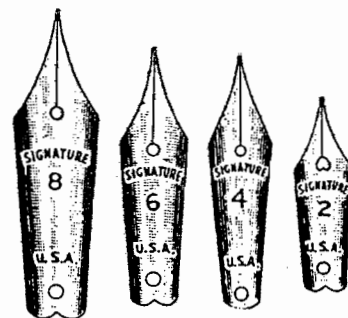

THE LEADING PEN ACCESSORY HOUSE IN THE U. S. A.

GOLD PLATED POINTS

Small Points ..... Dozen, 15c Gross, \$1.50  
 Large Points ..... Dozen, 20c Gross, 1.90

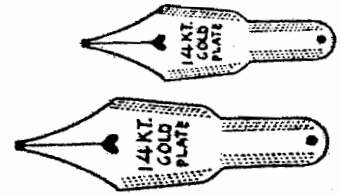

STAINLESS CORROSION-PROOF

14K Gold Plated F. P. Points

5c each  
 45c doz.  
 Gross, \$4.25

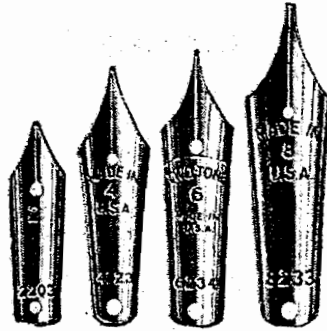

TWO-TONE

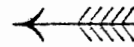

Dozen, 50c  
 Gross, \$4.75

RADIITE IRIIDIUM TIPPED POINTS

Made like the best quality gold nib highly-polished and non-tarnishable. These points will wear a lifetime.

Sizes 1 to 6 ..... Each 13c  
 Dozen, \$1.25  
 Size 8 ..... Each 18c  
 Dozen, \$1.75

RADIITE IRIIDIUM TIPPED TWO-TONE

GOLD PLATED NIB



Sizes 2—4—5  
 Each, 15c  
 Dozen, \$1.50

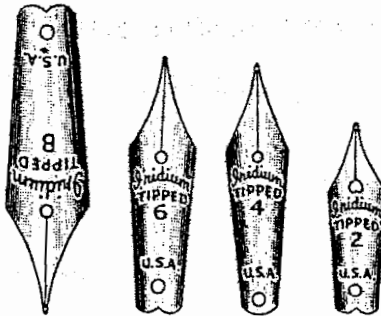

IRIDIUM TIPPED DURIUM SMOOTH WRITING NIBS

Each ..... \$ .10  
 Dozen ..... .90  
 Gross ..... 8.00

PEN REPAIR ENVELOPES

<i>This space for your address</i>		FOUNTAIN PENS MECHANICAL PENCILS REPAIRED PROMPT - EFFICIENT SERVICE	
MAKE	REPAIR NO.	DEALER	DATE
OWNER			

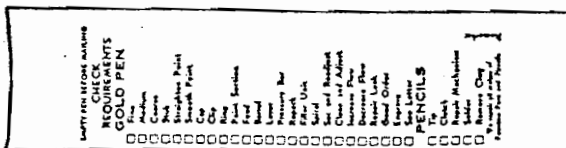

THESE LOW PRICES CANNOT BE DUPLICATED

100—60c 500—\$2.25 1000—\$4.00

3000 Your Name and Address Imprinted.....\$15.00  
 5000 Your Name and Address Imprinted.....\$23.50



## PARKER VACUUM FILLER UNITS

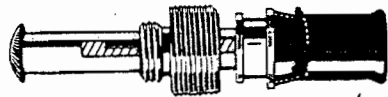

COMPLETE FILLER UNIT

SLENDER  
STANDARD  
OVERSIZE  
40c each

### PARKER TUBE FEEDS

20c each



### DIAPHRAGM FOR PARKER FILLER UNIT

SLENDER (Ladies)                      Each, 10c  
STANDARD (Medium)                      Dozen, 80c  
OVERSIZE (Large)

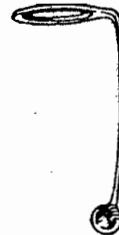

### PARKER DUOFOLD CLIPS

Each, 25c  
Dozen, \$2.40



PARKER VACUUM CLIPS  
Gold Filled  
or  
Chrome  
40c each

### PARKER CLIP SCREWS or BLIND CAP SCREWS



Each, 5c  
Dozen, 50c

BLIND CAP BANDS    Ea. 5c  
Gold Filled or Chrome    Doz. 50c

### PARKER DUOFOLD BLIND CAPS (End Caps)

SENIOR  
JUNIOR  
LADY  
10c each  
80c dozen



### KNOCKOUT PIN FOR PARKER TUBE FEEDS

Knocks out feed without removing tube.

A TIME-SAVER

30c each

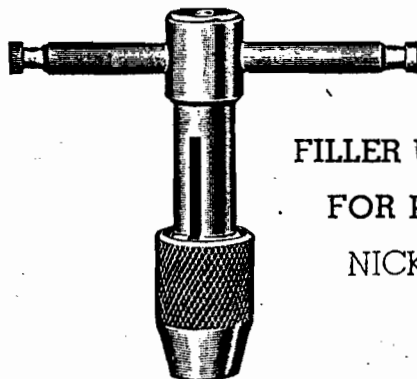

FILLER UNIT REMOVING TOOL  
FOR PARKER VACUMATIC  
NICKEL PLATED FINISH

75c each

### PARKER FILLER UNIT REMOVING TOOL

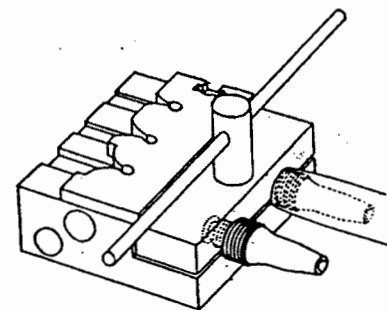

TAKES ALL SIZES

\$2.25 each

\$2.00 WILL BRING YOU ABOUT \$50.00 IN BUSINESS

IT PAYS TO  
USE THE BEST



RUBBER SACS  
ARE MADE OF  
PURE GUM RUBBER

Guaranteed  
Not To Swell  
From Acid Inks

Will Not  
Dry or Crack

Guaranteed  
Always Fresh

1 Dozen ..... \$ .40  
3 Dozen ..... 1.00  
100 Sacs ..... 2.00  
200 Sacs ..... 3.50  
300 Sacs ..... 4.50  
500 Sacs ..... 6.00  
1000 Sacs ..... 10.00

2000 or over  
@ \$9.00 per M

**SACHOOK**

For Removing  
Old Sac From  
Barrel

Each, 10c  
Dozen, 75c

ACTUAL SIZE		
	No. 12S	
	14EL	
	15S	
	15L	
	15EL	
	16L	
	16S	
	17EL	
	17S	
	18L	
	18S	
	18EL	
	19EL	
	20EL	
	20M	
	20S	
	22L	
	23M	
	23EL	
	23L	
	24EL	

LEADING PEN PARTS HOUSE IN U. S. A.

WOOD CENTER  
BRISTLE BRUSH WHEELS

No.	Diameter	Price Each	Dozen
41G	2 1/2"	30c	\$3.00
42G	3"	35c	\$3.50

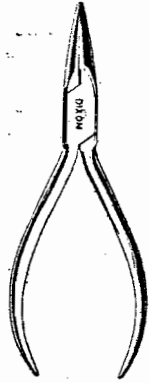
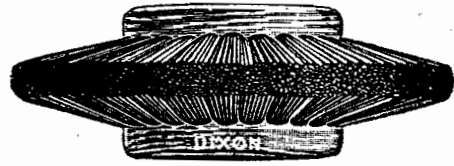

POINT  
STRAIGHTENING  
PLIERS

Just the Right Size  
Specially Ground  
Made of  
Best Swedish Steel

\$1.00 each

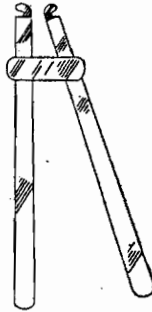

CLAMPS

To Fasten  
Waterman Levers  
Adjustable For  
All Sizes

\$1.25 each

TAPE COVERED PLIERS

For Removing Point Sections  
Without Marring

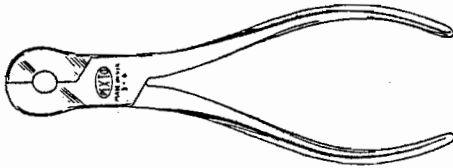

A Handy Tool for Many Uses

Price \$1.25

INNER CAP REMOVERS

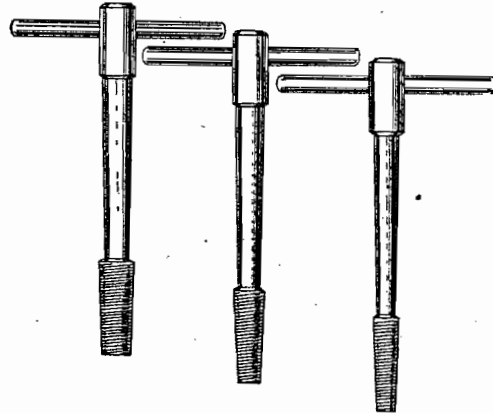

Will Remove Inner Caps with the  
Least Amount of Breakage  
No Shop is Complete Without a Set  
Each \$1.25 Set of Three \$3.50

SECURITY  
*Pen Clips Pencil*

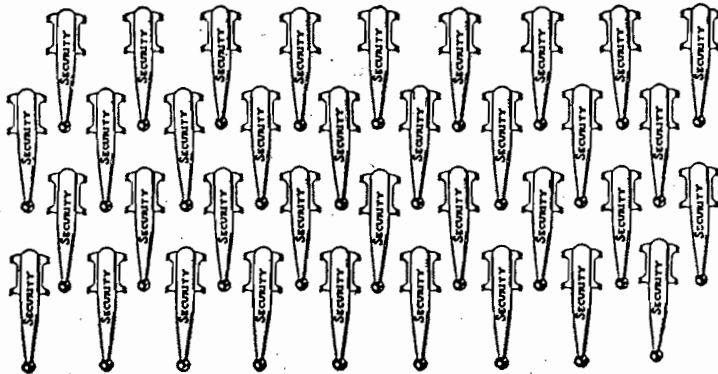

SLIP ON CLIPS



Card of 3 dozen \$1.20

Gross \$4.50

SMALL SIZE FOR PENCILS  
MEDIUM AND LARGE  
FOR PENS

PENMEN FOR OVER TWENTY YEARS

VACUUM PLUNGER RODS

To Fit Eversharp

40c each

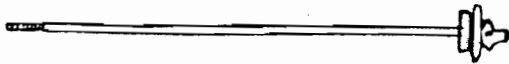

EVERSHARP  
RUBBER PLUNGER WASHERS

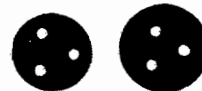

SMALL — LARGE

10c each

80c dozen

PLUNGER RODS

To Fit Sheaffer Vac

40c each

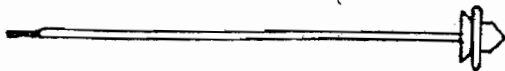

SHEAFFER  
PLUNGER WASHERS



SMALL — MEDIUM — LARGE

10c each

80c dozen

GOLD PLATED CAP BANDS

24 Assorted Bands  
for \$1.25

TO REPAIR BROKEN CAPS  
OR FOR ORNAMENTS

DRILL CHUCK



25c

DRILLS

10c each



Sizes No. 50 to No. 70

LEVERS



GOLD PLATED .....	25c dozen	\$1.80 gross
CHROME .....	20c dozen	1.50 gross
LEVER RINGS .....	10c dozen	.75 gross

GIFT BOXES THAT HELP TO SELL —



No. 40

DRESS UP YOUR PEN AND PENCIL SETS  
WITH THESE ATTRACTIVE BOXES

No. 46 SET BOX	20c each	
\$2.25 dozen		\$23.50 gross
No. 35 SINGLE	18c each	
\$2.00 dozen		\$22.50 gross

Color:

Ivory Bottom—Gold Covered Top

SILK LINED AND PADDED FOR EFFECTIVE DISPLAY

EVERY SET BOX HAS AN OUTSIDE PASTEBOARD COVER

# Victor

## CONVERTIBLE PEN AND PENCIL SET \$1.00

May be easily changed to a pen at one end and a pencil at the other. The pen has an amazingly large ink capacity and a transparent sac. Both are 3½" long and come in a split leather case. Comes in several colors—including white pearl. 6 sets on card \$3.60 net.

**HAND VISE** is used for holding small pieces of work. Die cast jaws—steel guide pin and screw—red enameled wooden handle. A very useful tool.

75c



## ACE REPAIRMAN'S REAMER

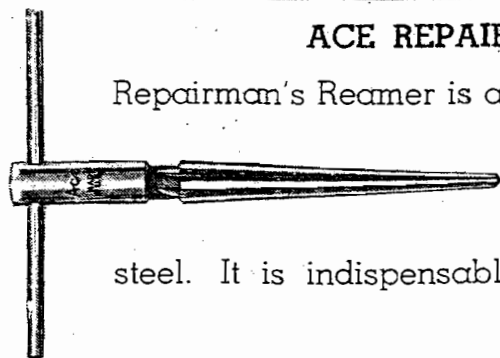

Repairman's Reamer is a long-tapered reamer ranging from 1/8" diameter at the point to 1/2" diameter at the large end. Reamer is made of the highest grade of tool steel. It is indispensable wherever holes are made.

90c

WE REPAIR FOUNTAIN PENS

A WINDOW SIGN THAT WILL ATTRACT 

Size 7" x 10"

25c each

\$2.00 dozen



drop in  
FOR A real PEN JOB  
WORK DONE WHILE YOU WAIT

**FOUNTAIN PENS**  
MECHANICAL PENCILS  
**REPAIRED**  
PROMPT SERVICE

A sign that will bring business in for you. Your first repair job pays for it. 10 x 7 with silver letters and silver borders on a black background.

25c each

\$2.00 dozen

PENMEN FOR OVER TWENTY YEARS

# We Repair All Makes of FOUNTAIN PENS — PENCILS RONSON and EVANS LIGHTERS

WE RETURN ALL WORK SAME DAY RECEIVED

## EVANS LIGHTER PARTS

No.	Each
1 Fuel Cap .....	\$ .15
2 Flint Cap .....	.15
3 Flint Wheel .....	.30
4 Fulcrum Screw .....	.10
5 Case Spring .....	.10
6 Flint Spring .....	.10
7 Plunger Spring .....	.10
8 Plunger .....	.30
9 Snuffer Cap .....	.30

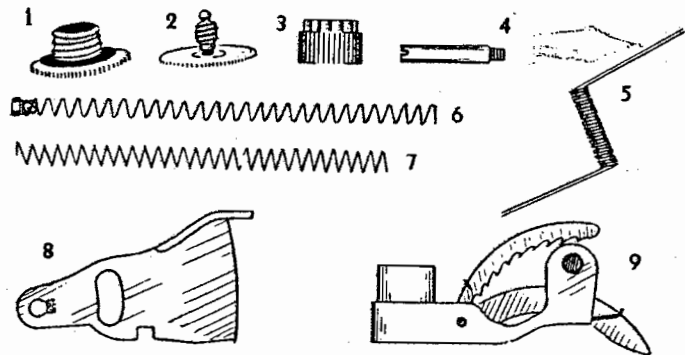

THE ABOVE PRICES ARE FOR LOOSE PARTS ONLY

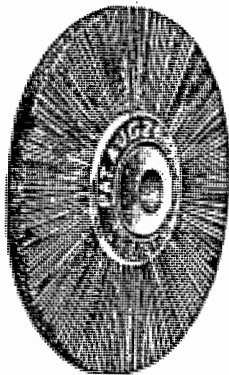

## WIRE WHEEL BRUSHES

NONE BETTER FOR  
POLISHING LIGHTER CASE  
OR CLEANING LIGHTER PARTS

- 3" Diameter 2 Row Str. Brass Wire..... 60c each
- 3" Diameter 3 Row Str. Brass Wire..... 80c each



### BUFFING STICK

Good quality ..... ea. 15c doz. \$1.50

GOLD ROUGE  
FOR USE ON BUFF STICK

25c



THE PUBLIC BUYS WHERE IT GETS SERVICE —

**INEXPENSIVE**



**STATIONARY  
GOOSENECK BRACKET  
AND FUNNEL**

Each ..... \$ .20  
Dozen ..... 1.80  
Gross ..... 14.40

**CHROME OR GOLD  
PLATED**

**FLAT EMBLEM**



2/3 of actual size  
Each ..... \$ .25  
Dozen ..... 2.50

**INEXPENSIVE DESK SET FOUNTAIN PENS**



	Each	Dozen	Gross
No. 12—With Durium Point .....	\$ .22	\$2.25	\$21.00
No. 13—Durium Point and Band on Barrel.....	.25	2.40	22.50
No. 15—With 14K Gold Point .....	.75	8.00	75.00

**PENCRAFT TWO-WAY SOCKET and  
SWIVELS FOR DESK SETS**

Gold Plated Swivel—Black Socket  
60c each \$6.00 dozen

Chrome Swivel—Black Socket  
50c each \$5.50 dozen

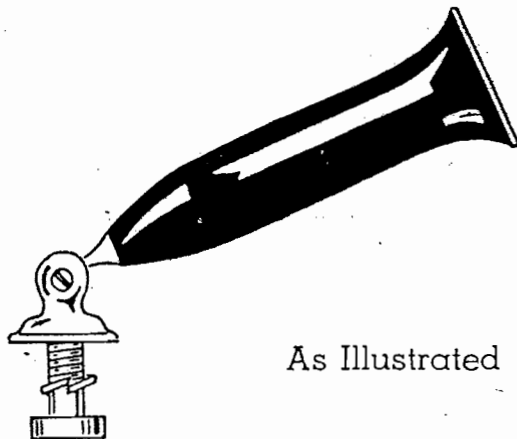

As Illustrated

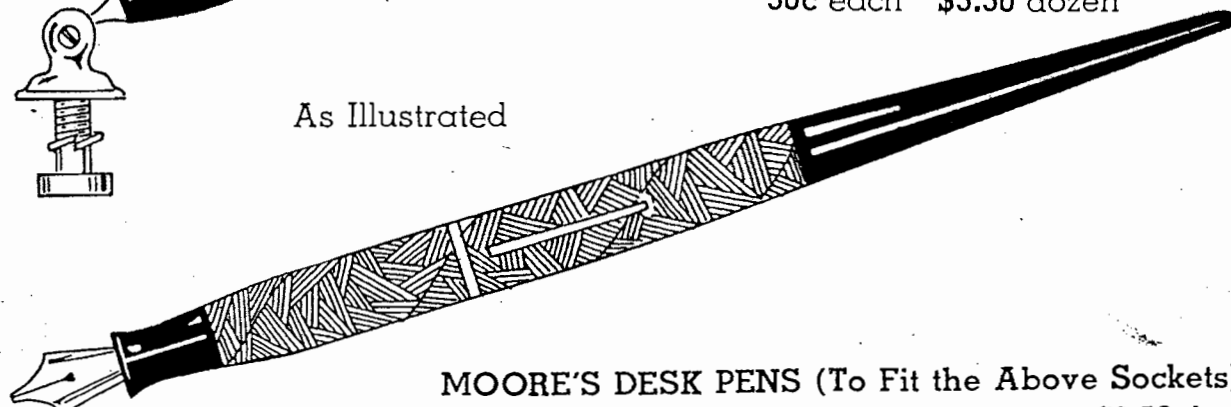

**MOORE'S DESK PENS (To Fit the Above Sockets)**

Beautifully Finished Holders—With Iridium Tipped Point \$ .90 ea. \$9.50 doz.  
With Solid Gold Point 1.25 ea. 14.40 doz.

Furnished in Black, Brown, Red, Marine Green and Mottled Grey

**FELT BASE PADS**

**Good Thick Green Round Felt Pads**

Size of Dime		Size of Quarter	
Dozen .....	\$ .10	Dozen .....	\$ .12
Gross .....	.90	Gross .....	1.00

DESK SET ORNAMENTS

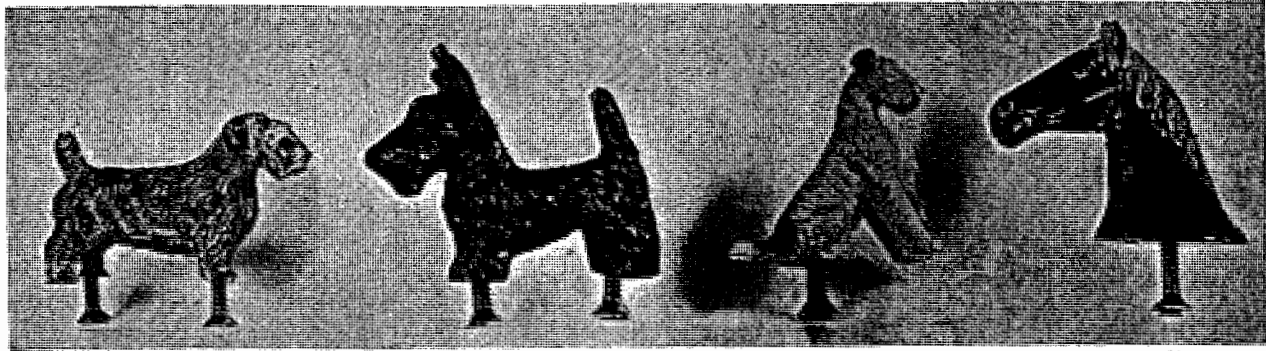

No. 20

No. 30

No. 40

No. 50

The above figures are 2/3 of actual size and come equipped with screw for attaching to base.

Price each ..... \$ .20  
Dozen ..... 1.80

Supplied with Screw Prongs and Nut for Attachment to Base

Illustrations are 3/4 size



No. 1

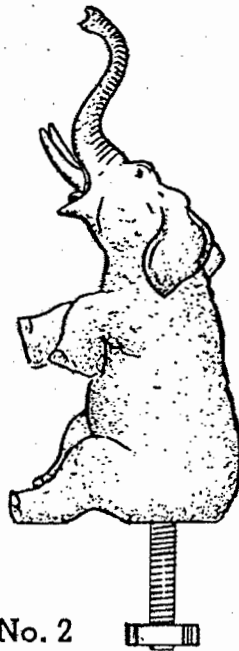

No. 2

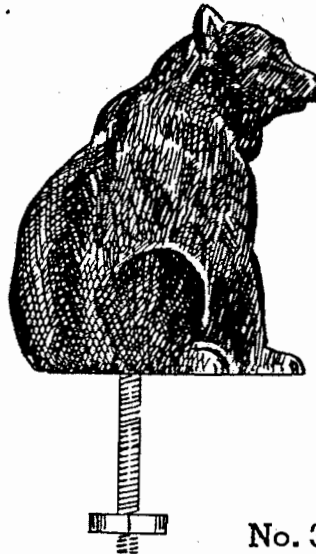

No. 3



No. 4

IN PASTEL GREEN OR IMITATION BRONZE

Price each, 50c Dozen, \$5.75

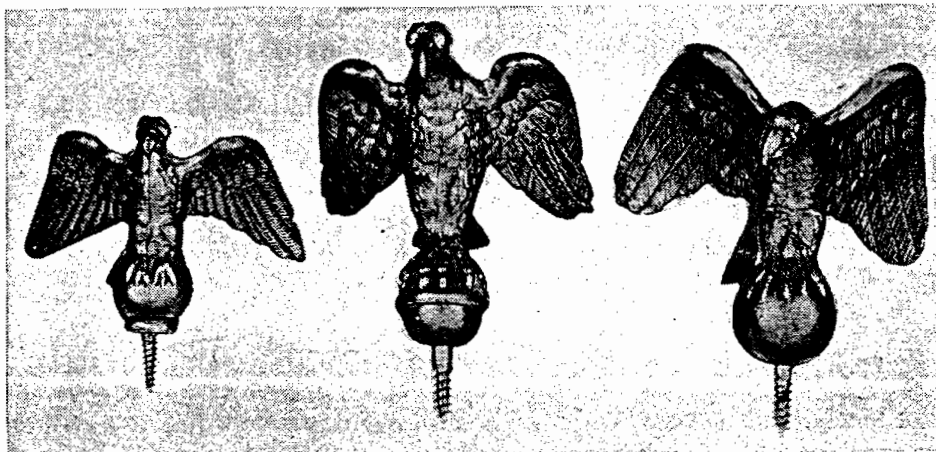

No. 16

No. 18

No. 27

May be attached to Wood-Plastic Materials and Marble Bases. We tell you how.

GILT EAGLES

Illustrations are 1/2 of actual size

Ea. Doz.  
No. 16 40c \$4.20  
No. 18 50c 4.90  
No. 27 75c 7.20

Equipped with Wood Screw.



# DO YOUR OWN REPAIRING — ORDER A KIT NOW

## No. 120 GRINDING OR POLISHING HEAD

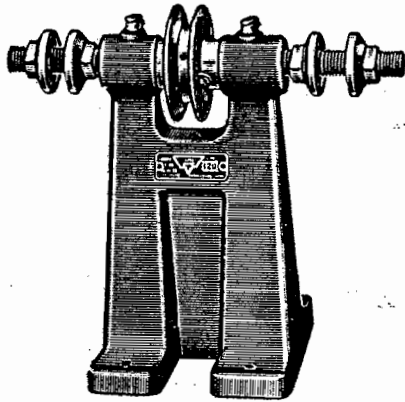

### FULL BRONZE BEARINGS

A stocky machine with a solid frame and ample base to withstand years of service. The spindle is  $\frac{1}{2}$  inch in diameter and runs in two bronze bearings  $1\frac{1}{4}$  inches long. It is wick-oiled from two large reservoirs in the casting just below the bearing on either side which are fed through the spring top oilers.

The spindle is threaded at both ends and carries two sets of hardened flanges  $1\frac{1}{4}$  inches in diameter to carry wheels up to 4 inches in diameter with a  $\frac{3}{4}$ -inch face and  $\frac{1}{2}$ -inch hole. The V-belt pulley is  $2\frac{1}{4}$  inches in diameter. Designed to drive from above, behind or below.

Frame nicely finished in battleship gray. Flanges polished, nicked and buffed.

Height	Base	Weight	Price Each
6 inches	$4\frac{1}{8} \times 4\frac{1}{8}$ inches	$5\frac{1}{4}$ lbs.	\$2.75
ADD POSTAGE			

## No. 125 GRINDING OR POLISHING HEAD

### FULL BRONZE BEARINGS

Exactly the same as No. 120 above, but fitted with a clean, deep taper thread spindle in place of the wheel arbor on the left. This permits the use of buffing wheels and a great variety of wheels built on wood centers, and on the right an all-steel three-jawed chuck, that holds rods or drills from 0 to  $\frac{3}{8}$  inch in diameter. Height given is to center of spindle.

Height	Base	Weight	Price Each
6 inches	$4\frac{1}{8} \times 4\frac{1}{8}$ inches	5 lbs.	\$3.30
ADD POSTAGE			

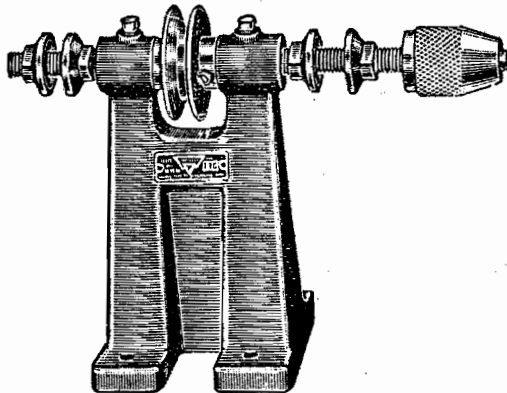
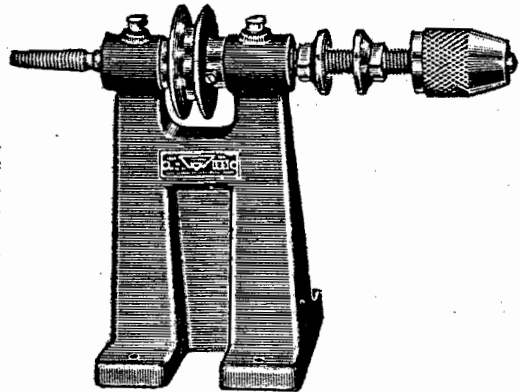

## No. 130 GRINDING OR POLISHING HEAD

### FULL BRONZE BEARINGS

Exactly the same as No. 120 above, but with a longer spindle on the right side on which is a nicked and buffed all-steel chuck with three hardened jaws that holds 0 to  $\frac{3}{8}$  inch round shank drills or rods.

Height	Base	Weight	Price Each
6 inches	$4\frac{1}{8} \times 4\frac{1}{8}$ inches	$5\frac{1}{2}$ lbs.	\$3.50
ADD POSTAGE			

## No. 155 POLISHING HEAD

### "OILITE" BRONZE BEARINGS

A heavier head with bigger base, greater height, running in two "Oilite" bronze bearings. The spindle is  $\frac{3}{4}$  inch in diameter and carries a deep, clean taper thread and a pair of wheel flanges on one end and a pair of flanges and chuck on the other.

The wheel flanges are  $1\frac{1}{4}$  inches in diameter and hold wheels up to 6 inches or larger in diameter with 1-inch face and  $\frac{1}{2}$ -inch hole. Hardened steel flange nut. The chuck has three hardened steel jaws and holds 0 to  $\frac{3}{8}$  inch drills or rods. Polished V-belt pulley is  $2\frac{1}{4}$  inches in diameter and drives from above, behind or below.

Frame finished in battleship gray enamel. Flanges and chuck nickel plated and buffed.

Height	Base	Weight	Price Each
$7\frac{1}{2}$ inches	$5 \times 5$ inches	9 lbs.	\$7.15
ADD POSTAGE			

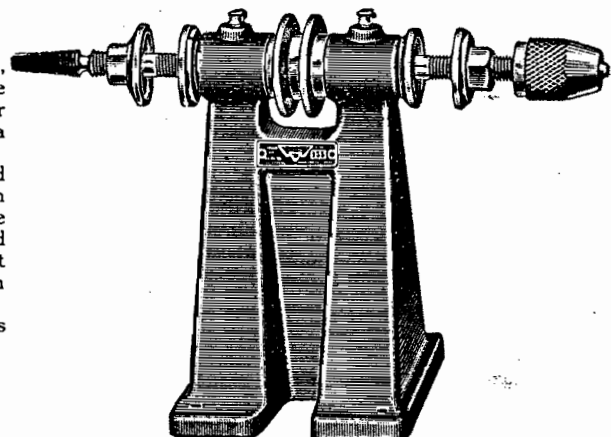

**No. 501 M-S POLISHING HEAD**

A big value in a small machine. The 1/2-inch spindle is equipped with two sets of flanges for holding wheels up to 3/4 inch wide with 1/2-inch holes, also a three-jawed chuck for holding round shanks up to 1/4 inch in diameter. Pulley with two grooves for V belt is 1 3/4 inches in diameter. Oil holes with brass plugs provided. Base black and pulley red enameled.

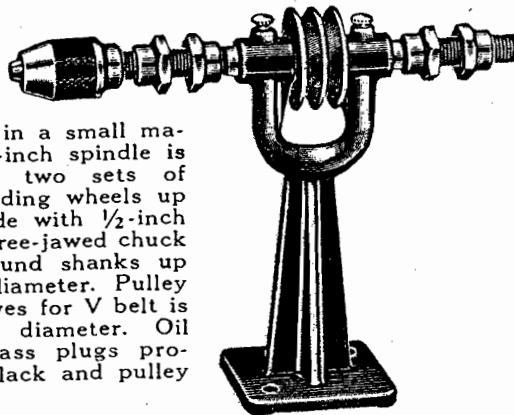

Height 6 3/4 inches	Weight 2 1/4 lbs.	Price Each <b>\$1.70</b>
------------------------	----------------------	-----------------------------

ADD POSTAGE

**No. 15 M-S VISE**

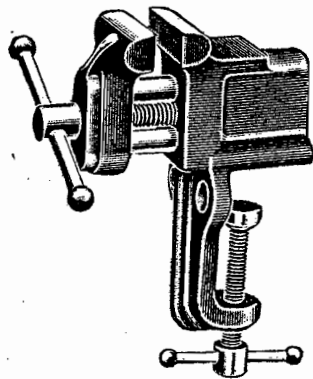

A small vise of the well known twin guide rod construction which, with the clean cut screw, gives smooth action and rigidity. Jaws meet squarely. Clamps to bench up to 2 inches thick. Machined jaws 1 1/2 inches wide. Body casting finished in red and movable jaw casting in black enamel.

Jaws 1 1/2 inches	Weight 2 1/8 lbs.	Price Each <b>\$1.00</b>
-------------------------	----------------------	--------------------------------

ADD POSTAGE

**No. 1700 M-S VISE**

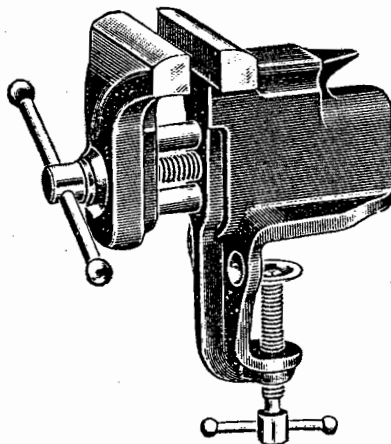

A strong, rigid vise with machined jaws 2 1/2 inches wide that open 2 1/4 inches. Jaws meet squarely. Twin steel guide rod construction. Small anvil on body casting. Body finished in red, movable jaw in black enamel. Clamps to bench up to 2 inches thick.

Jaws 2 1/2 inches	Weight 3 1/2 lbs.	Price Each <b>\$1.40</b>
-------------------------	----------------------	--------------------------------

ADD POSTAGE

**CANTON FLANNEL POLISHING BUFFS**

Machine Sewed

3" Diam. 30 Ply 3 Rs.	25c ea.	<b>\$2.30 doz.</b>
4" Diam. 30 Ply 3 Rs.	30c ea.	<b>\$2.60 doz.</b>
5" Diam. 30 Ply 3 Rs.	35c ea.	<b>\$3.40 doz.</b>

**CARBORUNDUM WHEELS**

With Lead Centers

For General Grinding Work,  
Tools, Parts, Fittings, etc.

3" Diam. x 3/8" thick 75c ea.

4" Diam. x 1/2" thick \$1.25 ea.



**LEAD CENTER MUSLIN POLISHING BUFFS**

3" Diam. 54 Ply 15c each  
**\$3.55 dozen**

4" Diam. 54 Ply 40c each  
**\$4.15 dozen**

5" Diam. 54 Ply 50c each  
**\$5.40 dozen**

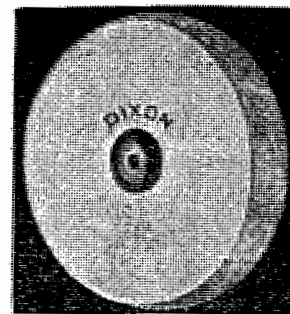

**MUSLIN POLISHING BUFFS**

Machine Sewed

3" Diam. 35 Ply 15c each  
**\$1.40 dozen**

4" Diam. 42 Ply 20c each  
**\$1.80 dozen**

5" Diam. 45 Ply 25c each  
**\$2.50 dozen**

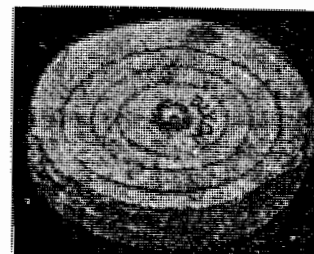

DO YOUR OWN REPAIRING — ORDER A KIT NOW

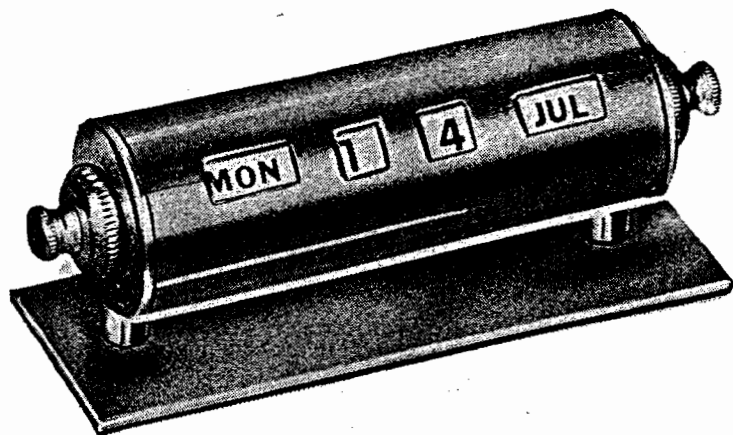

**PERPETUAL CALENDAR**

A patented, perpetual solid brass calendar with solid brass base designed to function for 50 years. Also useful as a paper weight.

Bronze or Chrome highly polished.

Also equipped with screw prong and nut for attachment to base.

Each \$1.25

Dozen \$12.00

**STERLING SILVER — ROLLED GOLD PLATE**

50c

**GIFT**  
Pencils by **CROSS**

\$1.00

A quality line that attracts additional pencil business irrespective of what other styles you carry

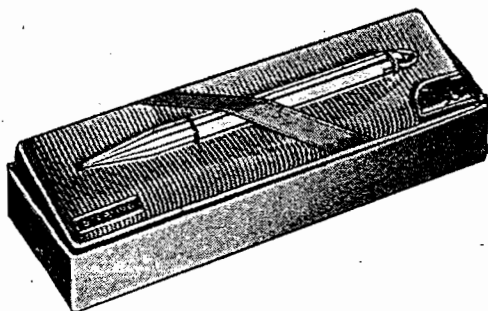

No. 396 — Sterling Silver  
No. 392 — 1/30 — 10 Kt. Rolled Gold Plate. Practical for bridge prizes, etc.  
Retail at 50c \$4.00 dozen net

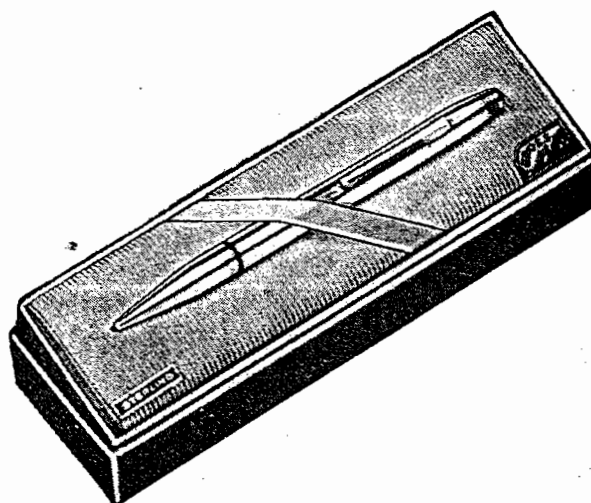

No. 520 — Sterling Silver  
No. 510 — 1/30 10 Kt. Rolled Gold Plate with clip.  
Retail at \$1.00 \$7.20 dozen net

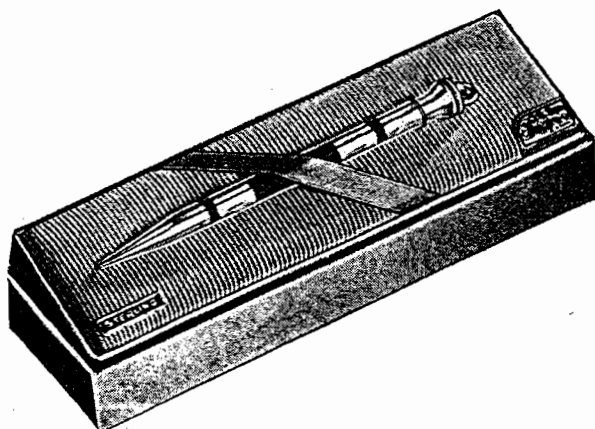

No. 899—Sterling Silver and Black Enamel.  
No. 889—1/30-10 Kt. Rolled Gold Plate and black enamel. Light weight, Slender.  
Retail at \$1.00 \$7.20 dozen net

**A LEADING GIFT ITEM IN  
AMERICA'S FINEST STORES**

**Every Pencil Guaranteed  
All Pencils Individually Boxed**

PENCRAFT, INC. • 5 BROMFIELD STREET • BOSTON, MASS.

BOSTON'S FINEST PEN SHOP

# EVERFEED

## REPEATING PENCIL



THE PENCIL THAT LOADS ITSELF

CARDED 1 DOZEN TO A CARD

Black 59c Retail—Dealer's cost \$4.25 doz.

Colors 69c Retail—Dealer's cost \$4.95 doz.

Made in beautiful DuPont Pyralin, black and various pearl colors, trimmed with gleaming chromium.



Load it once... for a whole year



Just snap the cap for a new point.

for ..

Rugs

Clothing

Papers

Linens

Etc.

**BLITZ**  
*for*  
**BLOTS**  
ONE SOLUTION  
**INK**  
*and*  
**STAIN**  
**ERADICATOR**



*Removes*  
INK and STAINS  
*from*  
PAPER, CLOTH, RUGS  
LINEN, ETC.

**15¢** SUGGESTED  
RETAIL  
PRICE

Retail

\$1.80 dozen

\$21.60 gross

Dealer's cost

\$1.00 dozen

\$9.75 gross

HERE'S  
A GOOD  
PROFIT  
FOR YOU

The WASP

**Clipper** NEW!

THESE POPULARLY PRICED,  
BEAUTIFUL DESK SETS FOR—



• No. 472 Wasp Addipoint Desk Set. Pedrara Onyx Base, 2½" x 3½". \$1.95. Complete with Addipoint Desk Pen containing replaceable stainless steel point unit. • No. 476 Base of rich Black composition. 2¾" x 4½". \$2.95. • No. 478 base. Pedrara Onyx. 2½" x 3½". \$3.95. The latter two bases have 12K genuine gold points, iridium tipped.

## MORE GIFT PROFITS

### ORDER ASSORTMENT No. 531

Counter Display FREE	No. 472 Base.....	\$1.95 Retail	Bases Individually Boxed
	No. 476 Base.....	2.95 Retail	
	No. 478 Base.....	3.95 Retail	
Total Retail		\$8.85	

DEALER'S COST, \$5.31 • FULL PROFIT, \$3.54

DESIGNED TO SELL FAST

A COMPLETE PRICE RANGE AND DISPLAY AT A SMALL INVESTMENT

PENCRAFT, INC. • 5 BROMFIELD STREET • BOSTON, MASS.

LEADING PEN PARTS HOUSE IN U. S. A.

FAST-SELLING pens that offer REAL VALUE to every customer. GENUINE 12K GOLD, iridium tipped points having 5 times the value of ordinary brass and plated points, yet costing no more! Smart new design for comfort in hand and pocket. Built to take hard use and give long, faithful service. Practical and economical. The pen for the "School" and "Popular Price" market!

**ORDER ASSORTMENT  
No. W900**

1 doz. pens (assorted colors)  
Retails \$1.25 each  
\$15.00 per card

DEALER'S COST ..... \$9.00  
DEALER'S PROFIT ..... 6.00

Colorful Display Card actually HELPS sell these pens.

*The WASP* **GOLD** *Sensation*

**\$1.25** GENUINE 12 K GOLD POINT at IMITATION GOLD PRICE

WHEN YOU PAY FOR GOLD - BE SURE AND GET IT!

*Clipper*

Quality Gift Sets

**GENUINE 12K GOLD  
POINTED PENS  
Matched With  
CRISPLINE Pencils**

The Greatest Value in Its Price Class Today.

A Plus Offer For Quick Turnover and Profit.

Genuine 12K gold points iridium tipped, giving 5 times the value of imitation gold, yet costing no more.

**Order Assortment  
No. 702**

6—WASP CLIPPER Sets—  
Assorted Colors.

(Pen \$1.25—  
Pencil \$1. separately)  
SET RETAIL PRICE —  
\$1.95 ea. in gift boxes.

1—Counter or  
Window Display — FREE.

Retails \$11.70  
Dealer's Cost . . . \$7.02  
Dealer's Profit . . . 4.68

WE OPERATE THE BEST EQUIPPED REPAIR SHOP

# The MOORE

"MASTERCRAFT" FOUNTAIN PENS

• •

THOUGH PRICED LOW  
THIS IS A HIGH QUALITY ITEM  
IN EVERY RESPECT

• •

PENS

RETAIL .....\$2.00

DEALER'S COST ..... 1.20

PEN & PENCIL SETS

RETAIL .....\$3.00

DEALER'S COST ..... 1.80

• •

CHOICE OF 4 COLORS:

BLACK — BROWN — GREEN — GRAY

SPECIFY COLOR

• •

No. 733SC — LADIES' SET

No. 733C — MEN'S SET

No. 73SC

No. 73LC

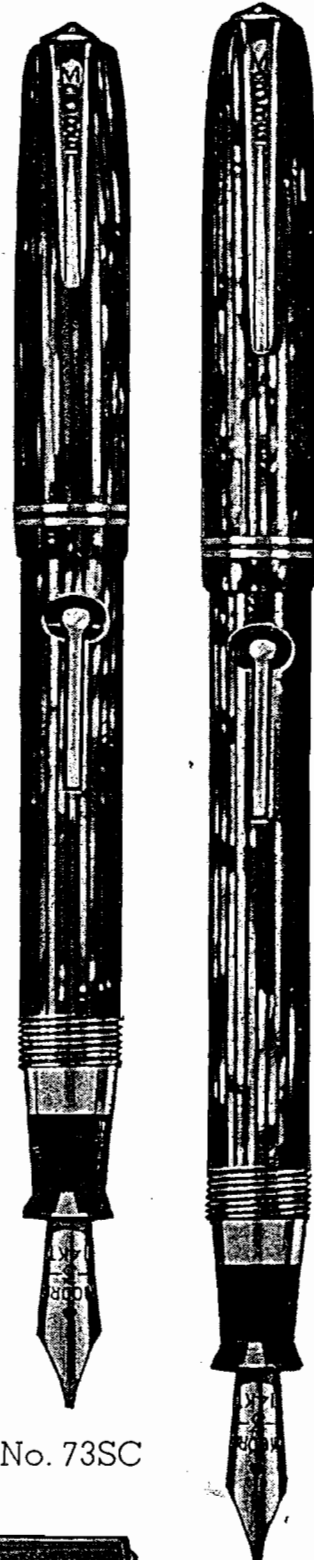
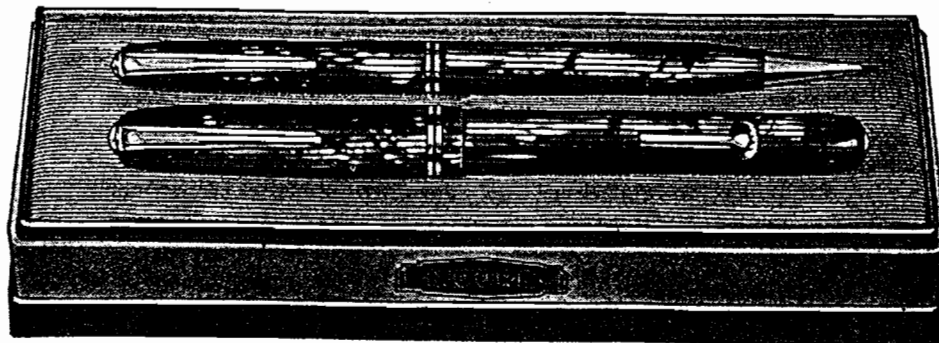

THE LEADING PEN ACCESSORY HOUSE IN THE U. S. A.

HERE IS THE **NEW WASP RITE-O-WAY SET**

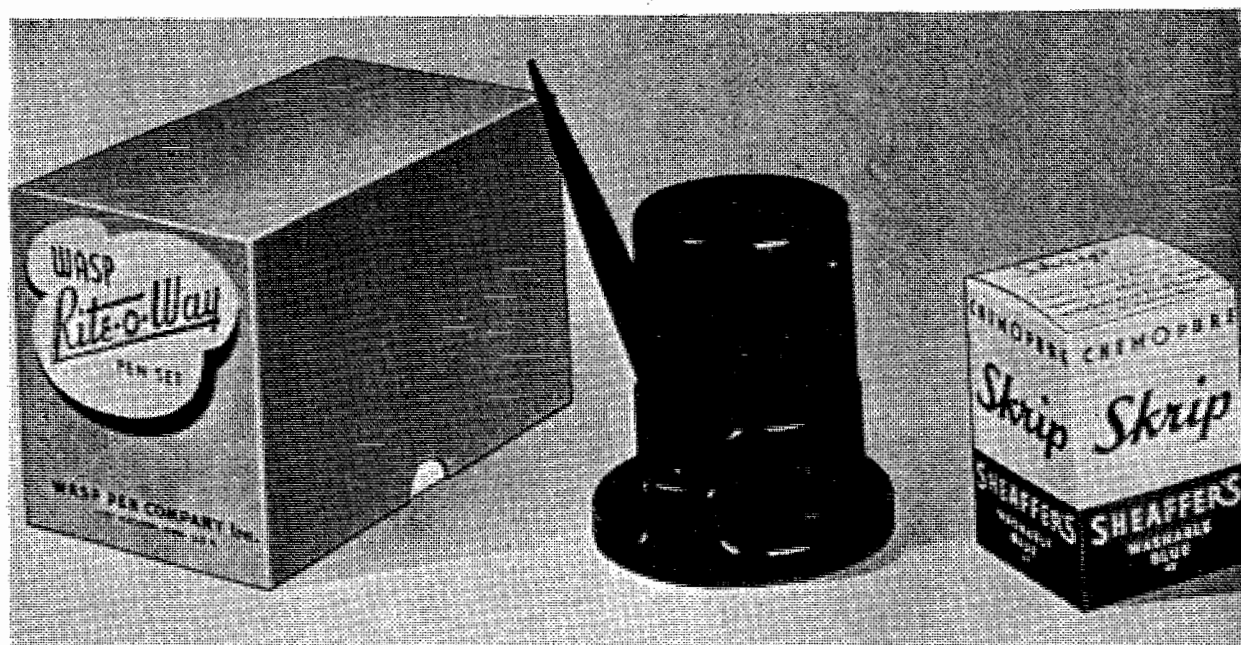

A \$1.50 VALUE NOW PRICED TO SELL COMPLETE

IF PURCHASED SEPARATELY	
Pen .....	\$ .75
Base .....	.60
2 oz. Skrip .....	.15
Total	<b>\$1.50</b>

FOR ONLY  
**98c**  
LIST  
Dealer Cost  
60c

**COUNTER - WINDOW  
DISPLAY CARD**  
Will be furnished with all orders of six or more. Set packed in attractive box illustrated above.

Available in Black only. Your choice of three points with this set: fine flexible, medium flexible, or stub. These are high quality stainless steel "turned over" points — smooth-writing, long-lasting.

**ENGRAVING** PENS—PENCILS—SETS — The engraving as illustrated below is cut right into the pen and pencil (not stamped).

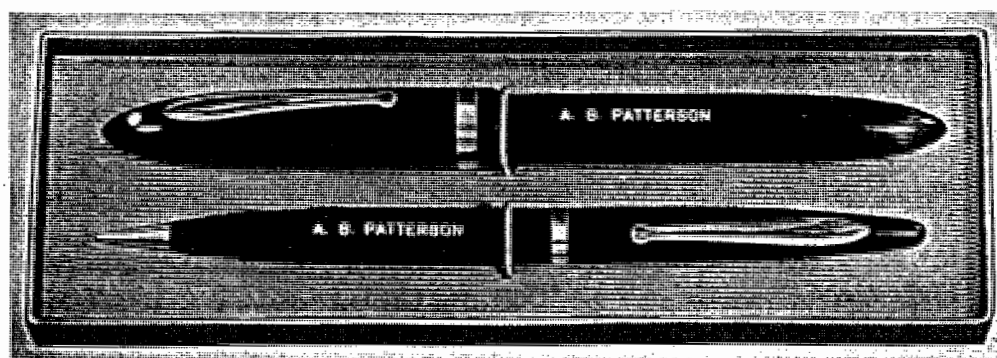

**Individual Name**—15c ea. line **All Same Name** (10 or more pieces) 10c ea. line  
(Set as above is considered as 2 lines)

Prices and samples on request for Special Quantity Engraving.

The above applies to hard rubber, celluloid, plastic materials—NOT METAL.



DO YOUR OWN REPAIRING — ORDER A KIT NOW

# Parker FOUNTAIN PEN AND PENCIL SETS

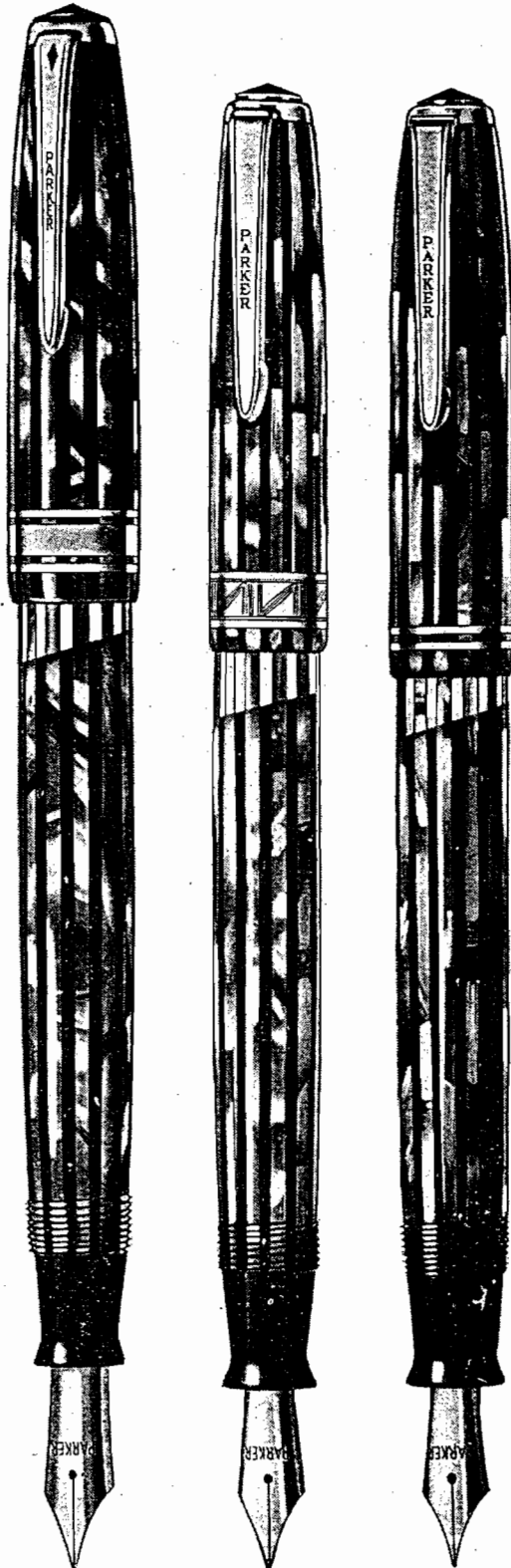

Duofold Senior

Duofold Major

Duofold Junior

Duofold Senior and Duofold Ingenue pens Guaranteed For Life, as Identified by the Blue Diamond.

Duofold—the name that made pen history—now more salable, more handsomely designed than ever! Featuring the sacless, leverless filling mechanism making possible an extra-large ink capacity, full vision ink supply and 14K gold nib tipped with Osmiridium. Styled in the appealing Laidtone motif—parallel bands of color accentuated by precision finished appointments. Matching pencils employ the famous Writefine extra-long, super-strong thin leads.

Duofold Senior                      Duofold Ingenue  
Colors: Blue, Maroon, Green  
Pen \$8.75 — Pencil \$4.00 — Set \$12.75

Duofold Major                      Duofold Debutante  
Colors: Blue, Maroon, Green  
Pen \$5.00 — Pencil \$2.50 — Set \$7.50

Duofold Junior                      Duofold Sub-Deb  
Colors: Black, Blue, Maroon, Green  
Pen \$3.95 — Pencil \$2.50 — Set \$5.00

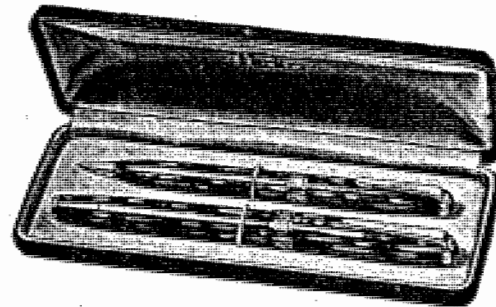

Duofold Major Set—\$7.50

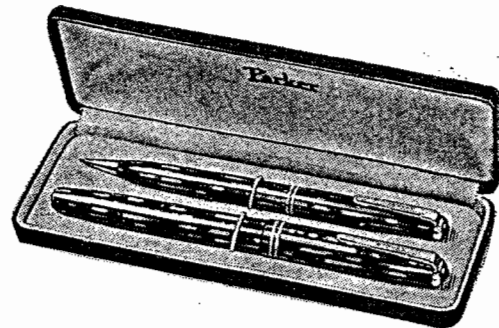

Duofold Junior Set—\$5.00

FACTORY DISCOUNT — 40% FROM ABOVE PRICES

PENCRAFT, INC. • 5 BROMFIELD STREET • BOSTON, MASS.

# Parker Duofold—Parkette Zephyr—Writefine

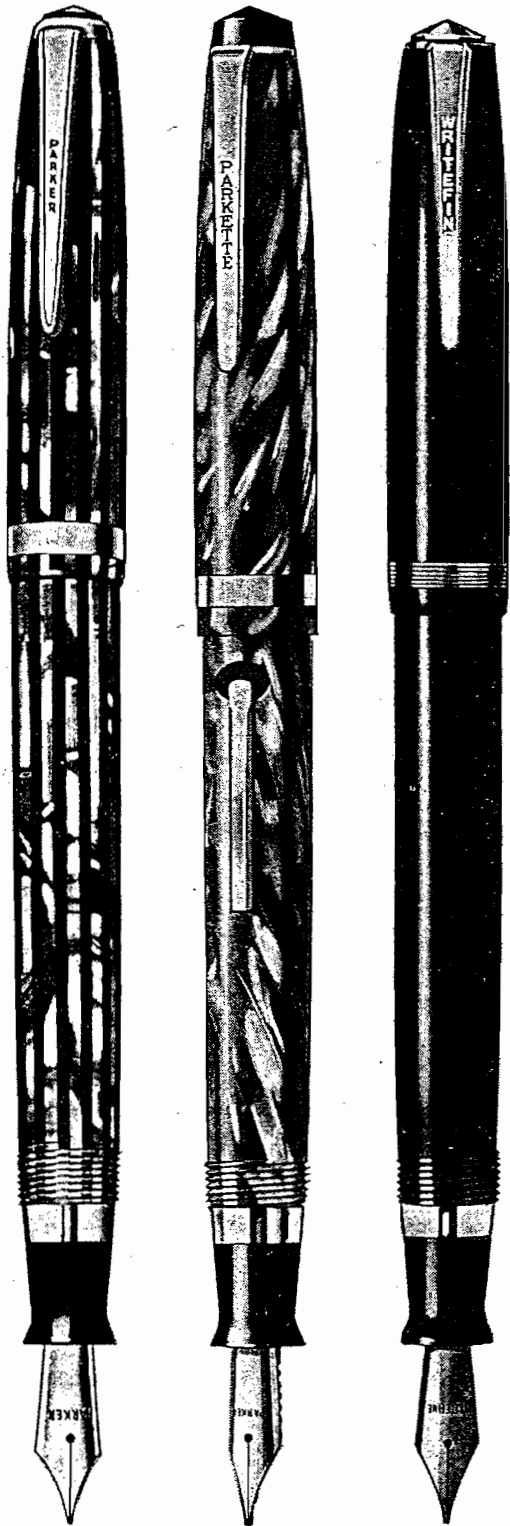

Duofold

Parkette  
Zephyr

Writefine

**DUOFOLD-DUOFOLD LADY**—Typical Duofold quality in a new low price range. Pen is of the sac type with one-stroke button filler. Visometer ink supply shows when to refill, sturdy end clip fits pen low in pocket, 14K gold nib tipped with durable Osmiridium. Matching pencils feature double-length, super-strength Write-fine thin leads. Two sizes—Duofold, for men—Duofold Lady, for feminine preferences.

Duofold

Duofold Lady

Colors: Black, Blue, Maroon, Green  
Pen \$2.95 — Pencil \$2.00 — Set Retail \$3.95

**PARKETTE ZEPHYR**—Finest in its price class. 14K gold nib tipped with Osmiridium, Visometer ink supply, lever filler, cap-top clip, distinctive marbled pattern. Matching pencil uses Writefine leads. Pen in one size only.

Colors: Blue, Black, Brown, Grey  
Pen \$1.95 — Pencil \$1.00 — Set \$2.95

**WRITEFINE** — The most advanced dollar pen ever offered. Visometer Ink Supply shows when to refill. Easy-action lever-filler, sturdy end clip, engraved band, radior nib tipped with Osmiridium. Pencil employs long, thin Writefine leads for extra writing mileage. One size only.

Colors: Black, Blue, Maroon, Green  
Pen \$1.00 — Pencil \$ .75 — Set \$1.75

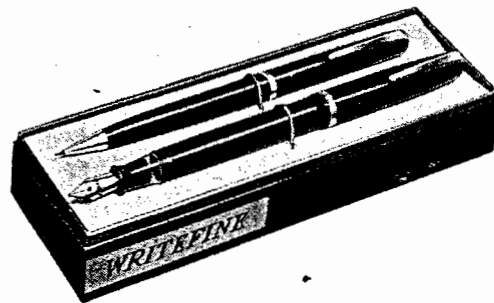

Writefine Set—\$1.75

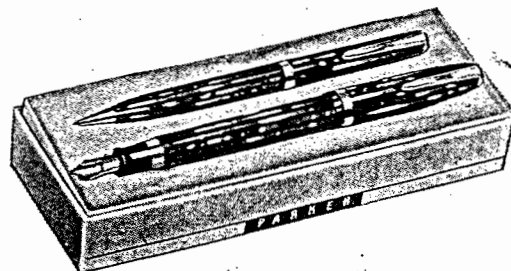

Duofold Set—\$3.95

FACTORY DISCOUNT — 40% FROM ABOVE PRICES

PENCRAFT, INC. • 5 BROMFIELD STREET • BOSTON, MASS.

The New Stag Slencils add new flatness and writing comfort.

Tried a week and they will be used for a lifetime.

Have new streamline smart appearance and use new Fine Leads. Propel, repel and expel. Have capacity for 8 spare leads and carry a large flat eraser. With initials and emblems this new Flat Pencil gives a jewelry appeal not heretofore available in pencils. Available in six standard colors—Black, Dark Blue, Light Blue, Red, Green, and Cream. Can be readily engraved with personal names or Glitter Gold embossed with names of Organizations, Colleges and Institutions. Fully guaranteed. In beautiful Gift Boxes.



ACTUAL SIZE

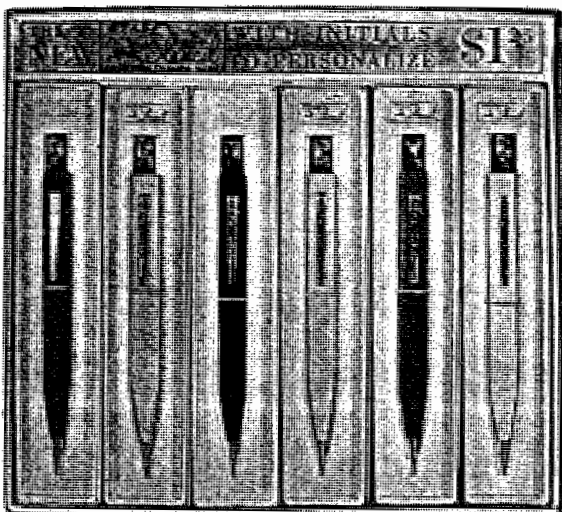

6 INITIALED SLENCILS  
WITH DISPLAY

Retail ..... \$7.50  
Dealer Cost ..... 4.50

PLAIN CAP  
SLENCIL

\$1.00 each Retail

6 ON EASEL

Retail \$6.00

Dealer Cost

\$3.60

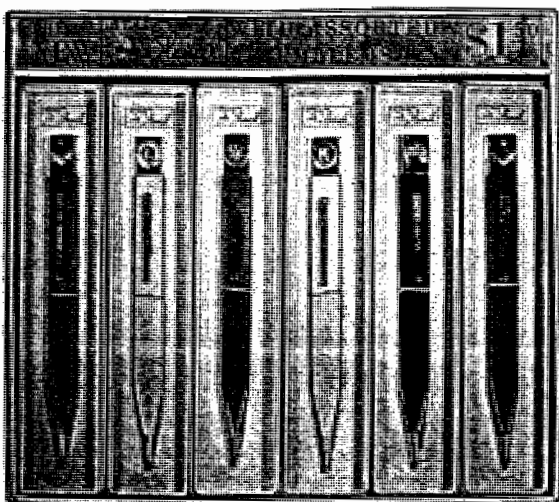

6 STAG SLENCILS  
WITH EMBLEM CAPS

Retail Value ..... \$9.00

Dealer Cost ..... 5.40

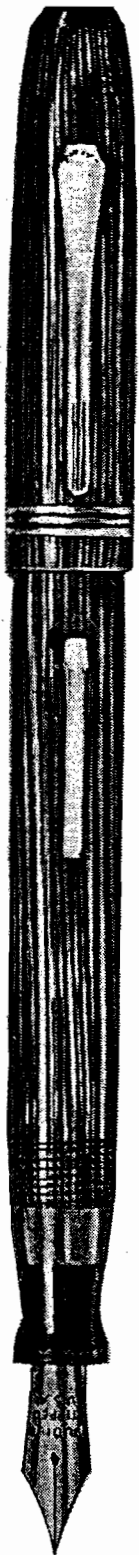

## EXTRAORDINARY VALUE

A popular priced fountain pen that represents unbeatable value—Streamline design—Special Two Tone iridium tipped point. Visualized ink-view section. New Clip brings the top of the pen flush to the top of the user's vest or coat pocket.

Three band effect on cap — black ends— all gold plated trim—in Beautiful colors—

SPARKLING BEAUTY

---

COMPARE IT WITH  
HIGHER PRICED PENS

---

\$3.80 dozen

PEN & PENCIL SETS IN GIFT BOX

\$7.20 dozen

SELL YOUR SERVICE WITH OUR CUTS

DISTINCTIVE CUTS FOR MANY USES



BUSINESS CARD OR SMALL BLOTTER SIZE

No. 23 \$1.25 each



LETTER HEAD  
OR ENVELOPE SIZE

No. 24 \$1.75 each

A SIZE FOR  
MANY USES

No. 25 \$2.25 each



SUPPLY  
YOUR OWN  
WORDS

No. 26  
\$1.75 each



No. 27 \$1.50 each

No. 28



\$ .75 each

No. 29



\$1.00 each

No. 30



\$1.25  
each

PENCRAFT, INC. • 5 BROMFIELD STREET • BOSTON, MASS.



No. 31

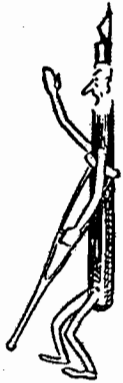

No. 32

No. 31  
75c  
No. 32  
75c  
Each

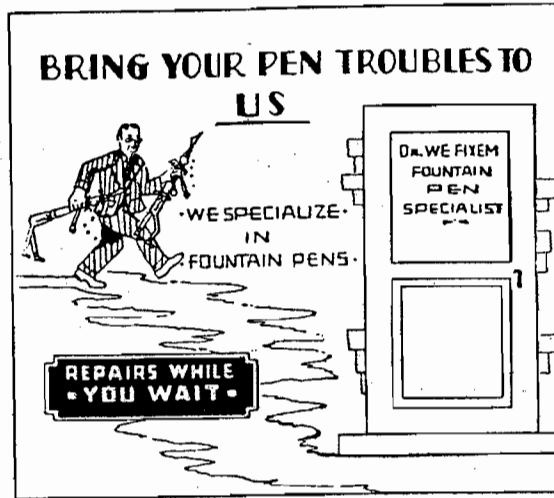

No. 33  
\$1.75  
Each



No. 34



No. 35

No. 34  
\$1.00  
Each  
No. 35  
\$1.00  
Each

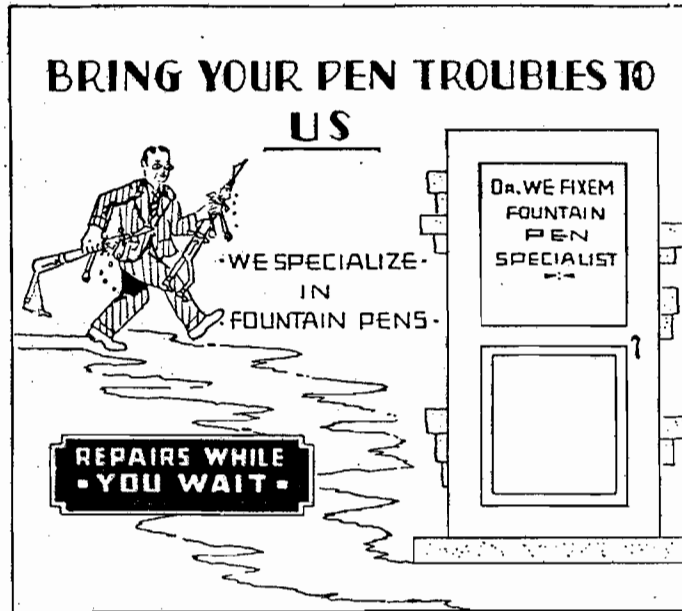

No. 36  
\$2.25  
Each

BRING YOUR PEN TROUBLES TO  
US



No. 37  
\$2.50  
Each



No. 38  
\$1.25  
Each

THE PUBLIC BUYS WHERE IT GETS SERVICE —

# A Proven Profit Producer THE IMPROVED FRANKLIN SIGNET EMBOSSER

EQUIPPED AS FOLLOWS:

- ONE FRANKLIN SIGNET EMBOSSER  
with cord, plug and exclusive  
"FINGER TIP HEAT CONTROL."
- ONE PEN ATTACHMENT —  
automatically self-aligning for any size  
pen or pencil . . . prints complete name  
in one operation.
- ONE ROLL OF GENUINE GOLD LEAF  
23 karat, full one inch wide.
- TWO SETS OF DURA CAST TYPE  
each in a handy type box.  
This Size Type }  
for Leather — } **O H G**  
This Size Type }  
for Pens — } THOMAS F. GRAY
- TYPE TWEEZERS
- FLANNEL FOR FINISHING
- PRACTICE EQUIPMENT—pieces of leather  
and pen barrel for practicing.
- COMPLETE SET OF INSTRUCTIONS

INCREASE SALES BY STAMPING  
NAMES OR INITIALS ON

Billfolds	Pen and Pencil Sets
Book Covers	Playing Cards
Leather Cases	Stationery
Fountain Pens	Unbreakable Crystals
Cardboard or Silk Lined Jewelry Cases or Boxes.	

**QUICK STARTING HEAT.** Machine may be set at correct heat for continuous stamping on leather goods, pens, etc.

Ideal for Demonstration Sales.

**RESULTS**—same as costlier machines.

**DE LUXE MODEL B28**  
Neat & Compact—Measures 8"x7"x7"

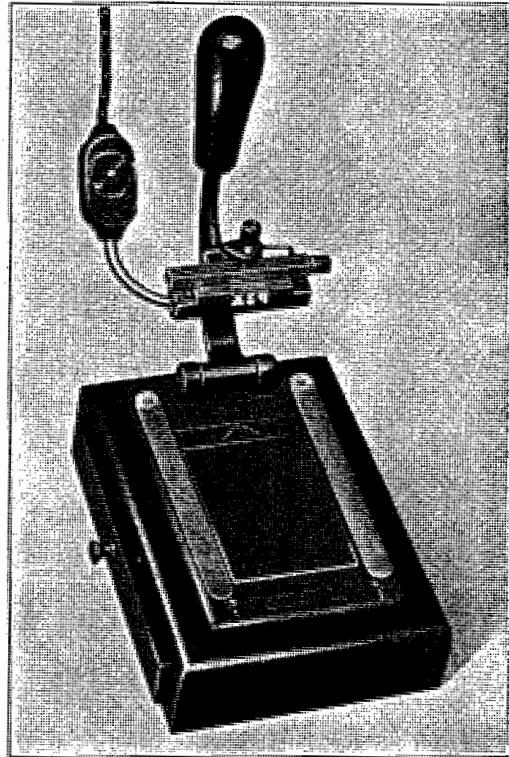

Mounted on Base Drawer for Supplies

Complete  
as  
described

**\$27.50**

Ready to use on 110-Volts —  
A.C. or D.C.

Shipping weight approx. 12 pounds

No complicated gadgets to  
remove and fuss with when  
changing names. Type sets  
directly into machine—in full  
view of operator.

PENCRAFT, INC. • 5 BROMFIELD STREET • BOSTON, MASS.

**NDA**

721 — 36 pt. Per Set \$5.25

**REA**

489 — 24 pt. Per Set \$5.25

**NEG**

488 — 24 pt. Per Set \$5.75

**EDN**

486 — 24 pt. Per Set \$5.75

**Ω Δ Ε**

Fraternal Letters Per Set \$4.50

**LCW**

3691 — 18 pt.

**ALICE**

Per Set \$4.50

**GHR**

3671 — 18 pt. Caps Per Set \$4.50

**ellen coleman**

3671 — 18 pt. Lower case Per Set \$4.50

**Ellen Coleman**

(3671 — Caps and Lower case)

**DBR**

3670 — 18 pt. Per Set \$4.50

**PLG**

3631 — 18 pt. Per Set \$4.50

3631 — Numerals Per Set \$2.50

**LEAF AND FOILS**

23K Gold Leaf — 10 ft. x 1 in. wide  
Per roll \$1.00

Imitation gold, aluminum, blue, ruby,  
green, black, white, yellow, terra cot-  
ta. 100 ft. x 3/4 in. Per roll 75c

**EHD**

3621 — 18 pt. Per Set \$4.50

**MARY EDWARDS**

3620 — 18 pt. Per Set \$4.50

**OHG**

2833 — 14 pt. Per Set \$3.75

**ROBERT OLIVER**

2430 — 12 pt. Per Set \$2.50

**ROBERT OLIVER**

2432 — 12 pt. Per Set \$2.50

**ROBERT OLIVER**

(2430 combined with 2432)  
Numerals for 2430 & 2432 Per Set \$1.50

**Mr. and Mrs. Fred Foster**

2440 — 12 pt. Caps & L.C. Per Set \$5.00

**THOMAS F. GRAY**

2411 — Fountain Pen Type Per Set \$5.25

**FRATERNAL EMBLEMS**



75c each Set of 13 \$6.00

**WOODEN PENCIL ATTACHMENT**—  
for Hexagon or Round. \$5.25

**Z ATTACHMENT**—for stamping optical  
cases, zipper tourist cases, etc. \$5.25

**STATIONERY ATTACHMENT** — for  
stamping on stationery, playing cards  
and greeting cards. \$5.25

**IMPRESSION PADS**—for use with Sta-  
tionery Attachment.  
Bundle of 50 pads \$1.00



## *Please Read — Then Order*

### TERMS AND INSTRUCTIONS FOR ORDERING

As a suggestion, to avoid delay in shipping your first order, include remittance in full.

OPEN ACCOUNTS—Our terms to responsible merchants, who have an established credit or satisfactory rating in the commercial agencies and who can furnish references acceptable to us, are 2%–10 days or net 30 days on all merchandise.

### DEPOSITS

We require a deposit equal to 20% on all C. O. D. orders.

### ORDERS LESS THAN \$3.00

Please send remittance in full with orders for \$3.00 or less. You save at least 20c C. O. D. and money order fees by doing so.

We will accept payments in U. S. Postage Stamps (small denomination please).

### OUR SHIPPING FACILITIES

We ship all orders the same day we receive them whenever possible.

Our liberal money-back guarantee proves to you beyond a doubt that we have absolute confidence in our merchandise.

### OUR MONEY BACK GUARANTEE

We absolutely agree to refund your money (less 10 per cent. for handling charges) for any merchandise that you cannot sell, or do not wish to keep, returned to us in first-class condition within 30 days from date of purchase.

PRICES SUBJECT TO CHANGE WITHOUT NOTICE

## HIGHEST PRICES PAID

## FOR OLD GOLD POINTS

WE OFFER

**94c.** . . . PER DWT FOR . . . **14k**

Prices Subject to Change Without Notice

SEND YOUR OLD GOLD POINTS IN NOW

USE THEM AS PART PAYMENT